

PUSHBUTTONS

SELECTOR SWITCHES

CONTROL & INDICATING DEVICES

Heavy Duty Oil Tight
Dust Tight
Hose Test Water Tight

- One Contact Block System For Both Miniature Or Full Size Buttons
- Versatile Modular Snap-Lock Together Components with Interchangeable Operators
- Wipe Action Contacts
- Space & Labor Savings
- Rugged Construction
- Bright LED Lamps (100,000 Hour Life)

ELECTRICAL & ELECTRONIC CONTROLS, INC.
7 WEST CROSS ST
HAWTHORNE, NY 10532
914-769-5000 FAX 914-769-3641
E-MAIL: eec@eecontrols.com

EE CONTROLS, LTD
17 STEWART COURT
ORANGEVILLE, ONTARIO
CANADA L9W 3Z9
519-941-6845 FAX 519-940-0514

Top Quality Engineered for Maximum Performance

SERIES D22
Miniature 22mm

SERIES D30
Full Size 30mm

Type 3R, 4, 12, 13, IP65, IP66
600 VAC / 300 VDC
UL A600

CSA, CEI, IEC, VDE, BSI Approved



MINIATURE 7/8" Mounting

GENERAL: Miniature - 7/8" Mounting

The new Series Heavy Duty Oil-Tight Control Units are a complete series of buttons and lights, designed to save panel space in A.C. or D.C. control circuit applications.

Control units are available assembled or in individual units for customer assembly.

ELECTRICAL RATINGS International Standards:

UL 600 Volt AC **10 AMP**
300 Volt DC

Other Codes: CSA, CEI, IEC, VDE, BSI

HEAVY DUTY OIL TIGHT

Type 12/13
Type 4 Hose Test
Type 4x (D22 Square)

OPERATIONAL TEMPERATURE RANGE:

-25 degrees centigrade to +70 degrees centigrade

MECHANICAL LIFE:

Three million operations, except selector switches and illuminated push buttons - one million operations, and joy-stick operators-500,000 operations.

CONTACT BLOCKS

<i>With Wipe Action</i>	New Number	Old Number
1 NO (Green Block)	C10B	SE10
1 NC (Red Block)	C01B	SE01
1 NO + NC	C11	SE11
2 NO	C20	SE20
2 NC	C02	SE02

All contact blocks are interchangeable



**NC CONTACTS
ARE POSITIVE
OPENING**

INDEX - Pushbuttons/Pilot Lights

Series D22 Miniature (7/8" Mounting) (22 mm)	Page
Complete Assembled Units	PB 3
Pushbutton Modules	PB 4
Light Modules/Pilot Light Sockets	PB 5
Illuminated Pushbutton Modules	PB 5
Selector Switch Modules	PB 5,6,8
Contact Blocks	PB 7
Joystick Operators	PB 8
Accessories / Installation	PB 9
Name Plate / Dimensions	PB 10
LED Lamps	PB 13
Twin Pushbuttons / Signaling Devices	PB 16
Series D30 Full Size (1 13/64" Mounting)	
Complete Pushbuttons (30 mm)	PB 11
Pushbutton Operators	PB 12
Illuminated Operators	PB 12
Pilot Lights/Illuminated Mushroom Operator	PB 13
Contact Blocks	PB 13
Joystick Operator	PB 13
Full Size Name Plates / Accessories	PB 14
Control Stations	
Emergency Stop Stations	PB 14,16
For D30 - Full Size	PB 15
For D22 - 7/8" Miniature	PB 15

PUSHBUTTONS

NOTE: All **Contact Blocks** are used with both **D22 Miniature** and **D30 Full Size** Operators.



C01B



C20

ELECTRICAL CHARACTERISTICS

UL (AC) A600	Thermal				DC RATING 250VDC	Thermal	
	120V	240V	480V	600V		120VDC	2.5 AMP 24VDC
MAKE	60	30	15	12	.27	.55	2.5
BREAK	6	3	1.5	1.2	.27	.55	2.5

CONTROL STATIONS



NEMA 4X
Outdoor



NEMA 12
M12 Indoor

Mounting and Installation

Series D22 mount is 7/8" Drilling. **Screw Ring Mount** is standard on Square Operations. **Two Screw Mount** is standard on Round (Metal) Operators.



D22-S
2 PRESSURE SCREW MOUNT
See Page PB 9

Enclosure Information

Type 12 Metal - Industrial Dust/Oil Tight.
Type 4X Non Metal (UL/CSA 4X)
Type S4 - Non Metal - Outdoor Hose Test. Water Tight.
Type M4 - Cast Aluminum. Outdoor Hose Test. Water Tight.

SERIES D22 COMPLETE PUSHBUTTONS

Pushbuttons (Includes Operator, Holder, and Contact Block)

600 Volt

* Polished Chrome
ROUND (Metal)



ASSEMBLED		SQUARE 4X			ROUND (Metal)	
Assembled Pushbuttons	Color Type	Catalog No. Square Design	List \$	Catalog No. Round Design	List \$	
	Green	D22 DT 10-G	\$16.80	D22 DTR 10-G	\$17.40	
	Black	D22 DT 10-B	16.80	D22 DTR 10-B	17.40	
	Gr Start	D22 DT 10-Start	17.50	D22 DTR 10-Start	18.10	
	Extd. Green	D22 DVT 10-G	16.80	D22 DVTR-00-G	17.40	
	Red	D22 DT 01-R	16.80	D22 DTR 01-R	17.40	
	Red "Stop"	D22 DT 01-Stop	17.50	D22 DTR 01-Stop	18.10	
	Extended Red	D22 DTV 01	16.80	D22 DTVR 01	17.40	

Mushroom Pushbuttons (Red)

	Momentary	D22 PT 01	24.30	D22 PTR 01	24.30
	Maintained	D22 PS 01*	37.20	D22 PSR 01-**	37.20
	Key Released	D22 SPS 01	52.50	D22 SPSR 01	52.50

Selector Switch (Maintained)

		*Twist Type / **Push/Pull Type				
	2 Pos	Black Handle				
		OX	D22 KS 10	22.00	D22 KSR 10	22.30
		XOO	D22 KS 11*	30.00	D22 KSR 11	30.30
	3 Pos	OOX				

*Includes two C10B N.O. Contacts

Pilot Lights (Includes Lens, Socket & Bulb Full Voltage)

(For Hi-Lumen LED Lamps use suffix HL and add \$15.00 -To List Price)
Example: D22 LS9-R-A-HL

	Red	D22 L9S-R*	22.00	D22 L9SR-R*	22.70
	Green	D22 L9S-G*	22.00	D22 L9SR-G*	22.70
	Yellow	D22 L9S-Y*	22.00	D22 L9SR-Y*	22.70

Illuminated Pushbuttons (Includes Lens, Socket, Bulb, and Contact Block)

* Indicates Voltage -A 115Volt
-G 24Volt

	Full Voltage (Flush)	Yellow	D22 LT9S-10Y*	34.40	D22 LT9SR-10Y*	34.60
		Green	D22 LT9S-10G*	34.40	D22 LT9SR-10G*	34.60
		White	D22 LT9S-10W*	34.40	D22 LT9SR-10W*	34.60
		Blue	D22 LT9S-10BL*	34.40	D22 LT9SR-10BL	34.60
		Red	D22 LT9S-01R*	34.40	D22 LT9SR-01R*	34.60

Push-to-Test Lights (Full Voltage)

* Indicates Voltage -A 115Volt
-G 24Volt

	Green	D22 LT9S-11G*	42.40	D22 LT9SR-11G*	42.60
	Red	D22 LT9S-11R*	42.40	D22 LT9SR-11R*	42.60

* Indicates Voltage -A 115Volt
-G 24Volt

ADD STANDARD NAME PLATES See Page PB 10		Type D22-S-X Blank		1.60	Type D22-R-X Blank		1.60
--	--	-----------------------	--	------	-----------------------	--	------



* All Round Metal Operators include the D22-S 2-Screw Mount as standard equipment.
Ring mount is optional (at same price), add suffix MR to Part #... Example: D22 DRT 10-G-MR

PUSHBUTTON (REQUIRED COMPONENTS)



OPERATOR + CONTACT BLOCK = COMPLETE UNIT

* See Page PB 7 for Contact Blocks

Color Type		Catalog No. Square Design	List \$		Catalog No. Round Design	List \$
------------	---	------------------------------	---------	--	-----------------------------	---------

Operators

Includes Contact Block Holder

SQUARE (4x)

Polished Chrome

ROUND (Metal)



 Chrome	Black	D22 DT301	8.80	D22 DT401	9.40
	Green	D22 DT302	8.80	D22 DT402	9.40
	Red	D22 DT303	8.80	D22 DT403	9.40
	Blank*	*D22 DT304	8.20	*D22 DT404	8.70
	Yellow	D22 DT305	8.80	D22 DT405	9.40
	Gr "Start"	D22 DT START	9.50	D22 DTR START	10.00
	R "STOP"	D22 DT STOP	9.50	D22 DTR STOP	10.00
	Extended Red	D22 DTV 312	8.80	D22 DTV 412	9.40
	Extended Green	D22 DTV 313	8.80	D22 DTV 413	9.40

Mushroom Operators

* Accepts Color Disc Inserts D114-X.
See Page PB 10 for inserts.

	Momentary	Red	D22 PT 310	16.30	D22 PT 410	16.30
		Black	D22 PT 311	16.30	D22 PT 411	16.30
	Maintained	Red (Twist Type)	D22 PS 308*	29.20	D22 PS 448*	29.20
		Red (Push-Pull)			D22 PS 408	14.00
	Key Released	Red	D22 SPS 309	44.50	D22 SPS 409**	44.50

* Twist Type ** Push-Pull

	Chrome Maintained Red Indicator Type	D22 TRI 418 with D22-S, 2 Screw Mount	\$ 35.00	The D22 TR 418 and D22 TRI 418 Emergency Stops, comply with the new EN 418 safety regulation. Section 4.1.11 "It shall <u>not be possible</u> for the control device to latch-in without generating the STOP command". Design: maintained latch, twist to release.
	Chrome Maintained Red	D22 TR 418 with D22-S, 2 Screw Mount	\$ 33.00	
	Legend Plates 22mm Round Yellow E-STOP 2 1/4" (Used on small enclosures)	D22 NPES 225 Plastic	\$ 4.00	
	Round Yellow E-STOP 2 3/4"	D22 NPES 275 Metal	\$ 9.00	
	Round Yellow E STOP 3" (Used with 60 mm Mushroom Operators)	D22 NPES 300 Plastic	\$ 4.50	

* Name Plates on Page PB 10

Block Holder



TYPE BN
BLOCK HOLDER is included with each operator as standard.

Type BN accepts up to 6 poles. All Type BN Block Holders accept 2 blocks (4 poles) as standard. For 6 pole operation, insert plug #D22-P must be added to operator.
#D22-P.....\$ 4.00 List

Spare Block Holder

D22 BN 2.60 List

For Contacts - see page PB 7

PILOT LIGHTS or ILLUMINATED PUSH BUTTONS



LED Bulbs Available - Page PB 13



LENS MODULE + LIGHT SOCKET (If Illum. P.B.) + CONTACT BLOCK = COMPLETE UNIT
 (*See page PB 7 for Contact Block)

Color Type	Catalog No. Square Design	List \$	Catalog No. Round Design	List \$
------------	---------------------------	---------	--------------------------	---------

Pilot Light Lens Module

*Polished Chrome

SQUARE (4x)

ROUND (Metal)

	White	D22 L 360	6.10	D22 L 460	6.80
	Green	D22 L 360	6.10	D22 L 461	6.80
	Yellow	D22 L 362	6.10	D22 L 462	6.80
	Blue	D22 L 363	6.10	D22 L 463	6.80
	Red	D22 L 364	6.10	D22 L 464	6.80

Illuminated Pushbutton Module (Flush)

	White	D22 LT 370	11.40	D22 LT 470	11.60
	Green	D22 LT 371	11.40	D22 LT 471	11.60
	Yellow	D22 LT 372	11.40	D22 LT 472	11.60
	Blue	D22 LT 373	11.40	D22 LT 473	11.60
	Red	D22 LT 374	11.40	D22 LT 474	11.60

Illuminated Pushbutton Module (Extended)

	White	D22 LTV 380	11.40	D22 LTV 480	11.60
	Green	D22 LTV 381	11.40	D22 LTV 481	11.60
	Yellow	D22 LTV 382	11.40	D22 LTV 482	11.60
	Blue	D22 LTV 383	11.40	D22 LTV 483	11.60
	Red	D22 LTV 384	11.40	D22 LTV 484	11.60

Illuminated Selector Switch Module 2 Position

For 3 Position: Add-3
 Example: D22 LKS 490-3 \$19.50

	White			D22 LKS 490	19.50
	Green			D22 LKS 491	19.50
	Yellow			D22 LKS 492	19.50
	Blue			D22 LKS 493	19.50
	Red			D22 LKS 494	19.50



"Round Metal Only"		Illuminated "35mm" Mushroom Head Operator		Illuminated "60mm" Mushroom Head Operator	
Maintained	Red	D22 LPS	29.20	D22 LPS 60	32.20EA
Momentary	Red	D22 LPT	16.30	D22 LPT 60	19.30 EA

Pilot Light Socket (also used on Illuminated P.B., Push-to-Test, and Illum. Mushroom)



		Full Voltage to 130V	Reduced from Full Voltage	List \$ 12.00	**Add Bulb (2 watt max)
		BL9SB**	110 Volt	27.30	BA9-6V 2.60
	Series Resistor 208/230	BR 220†	48 Volt	27.30	BA9-24V 2.60
	Series Resistor 120V	BR 110 ††			
	Transformer Type	BT 110*	24 Volt	44.40	BA9-48V 3.90
		BT 220*	24 Volt	44.40	BA9-130V
	BT 380*	24 Volt	44.40		

For LED Bulbs see page PB 13.



SERIES D22 SELECTOR SWITCHES MODULES

SELECTOR SWITCH (Contact Blocks not included, see example below)



Long Lever



Square Design - Black -



Round Design

Maintained Knob Selector Switch	Square (4X)	List	* Polished Chrome Round (Metal)	List
2 Pos	 Catalog No. D22 KS 315	\$ 14.00	 Catalog No. D22 KS 415	\$ 14.30
3 Pos	D22 KS 316	14.00	D22 KS 416	14.30

Maintained Long Lever Selector Switch

2 Pos	 D22 KS 317	\$ 14.00	D22 KS 417	\$ 14.30
3 Pos	D22 KS 318	14.00	D22 KS 418	14.30

Knob Type Selector Switches - Momentary:

2 Pos - Spring Return from right	D22 KT319	\$ 16.60	D22 KT419	\$ 16.90
3 Pos - Spring Return from left and right	D22 KT320	16.60	D22 KT420	16.90

Long Lever Selector Switches - Momentary:

2 Pos - Spring Return from right	D22 KTLR321	\$ 16.60	D22 KTLR421	\$ 16.90
3 Pos - Spring Return from right, left-maintained	D22 KRT323	16.60	D22 KRT423	16.90
3 Pos - Spring Return from left, right-maintained	D22 KLT324	16.60	D22 KLT424	16.90
3 Pos - Spring Return from both directions	D22 KLT322	16.60	D22 KLT422	16.90

For assembled switch, add Contact Blocks. (see example below)

Illuminated Selector Switch Module



White
Green
Yellow
Blue
Red

* For 3 Position: add -3
Example: LKS490-3 \$ 19.50

2 Position *	List \$
D22 LKS 490	19.50
D22 LKS 491	19.50
D22 LKS 492	19.50
D22 LKS 493	19.50
D22 LKS 494	19.50

ORDERING EXAMPLE

Complete Unit = Operator + Contact Blocks (Contact Block not included in price above.)

See bottom of page PB 7 for Contact Blocks)

Total

Knob type selector switch, momentary, 3 position spring return from left & right	=	D22 KT320 (\$16.60)	+	(1) C10B (\$8.00) (NO Contact)	+	(1) C01B (\$8.00) (NC Contact)	Complete price = \$32.60
---	---	------------------------	---	--------------------------------------	---	--------------------------------------	--------------------------

CONTACT SEQUENCE AS VIEWED FROM FRONT OF PANEL

	LEFT	CENTER	RIGHT	CONTACT BLOCK
1				C10 + C10 (SE10 + 10)
2				C10 + C01 (SE10 + 01)
3				C01 + C01 (SE01 + 01)
4				C01 + C10 (SE01 + 10)
5				C11 + C11 (SE11 + 11)
6				C11 + C20 (SE11 + 20)
7				C20 + C11 (SE20 + 11)
8				C11 + C02 (SE11 + 02)
9				C02 + C11 (SE02 + 11)
10				C20 + C20 (SE20 + 20)
11				C20 + C02 (SE20 + 02)
12				C02 + C20 (SE02 + 20)
13				C02 + C02 (SE02 + 02)

	LEFT	CENTER	RIGHT	CONTACT BLOCK
14				C11 + C01 (SE11 + 01)
15				C11 + C10 (SE11 + 10)
16				C20 + C10 (SE20 + 10)
17				C20 + C01 (SE20 + 01)
18				C02 + C10 (SE02 + 10)
19				C02 + C01 (SE02 + 01)
20				C01 + C11 (SE01 + 11)
21				C10 + C11 (SE10 + 11)
22				C10 + C20 (SE10 + 20)
23				C01 + C20 (SE01 + 20)
24				C10 + C02 (SE10 + 02)
25				C01 + C02 (SE01 + 02)
26	2 POS			C-10 (SE-10)
27	2 POS			C-01 (SE-01)

PUSHBUTTONS

Contact Block (Standard 10 Amp)



C01B



NC CONTACTS ARE POSITIVE OPENING

	New Number	Old Number	
1 NO	C10B	SE10	8.00
2NC	C20	SE20	16.00
1NC	C01B*	SE01	8.00
2NC	C02	SE02	16.00
1NO, 1NC	C11	SE11	16.00

Reset Button



Reset Button Adjustable from 1.2" to 5.1"
Dust, Oil, and Hose Test Water Tight. Nema 4, 13
D22 R-10 13.00
Plunger Only D22 R-10P 4.10

SERIES D22 SELECTOR SWITCHES MODULES

KEY SWITCH



Square Design
- Black Plastic -



Round Design

Key Operated Selector Switch - Maintained: Complete with Block Holder	Square (4X)	List	* Polished Chrome Metal	List
	Catalog No.		Catalog No.	
2 Pos. Key Removable in left position	D22 SSA327	\$44.60	D22 SSA427	\$46.60
2 Pos. Key Removable in right position	D22 SSE329	44.60	D22 SSE429	46.60
3 Pos. Key Removable in Both L. and R. Positions	D22 SSE330	44.60	D22 SSE430	46.60
3 Pos. Key Removable in center position	D22 SSA328	44.60	D22 SSA428	46.60
3 Pos. Key Removable in all positions	D22 SSAE332	44.60	D22 SSEA432	46.60
2 Pos. Key Removable in both positions	D22 SSAE331	44.60	D22 SSAE431	46.60
Key Operated Selector Switch - Spring Return:				
2 Pos. Spring Return from right (key remove in left position)	D22 STA325	44.60	D22 STA425	46.60
3 Pos. Spring Return from left and right (key remove. in center)	D22 STA326	44.60	D22 STA426	46.60
Special E7 Key Operated Selector Switch - Maintained:				
Key Removable in 2 Pos. Key Removable in left position			D22 SBA433	54.60
2 Pos. Key Removable both positions			D22 SBAE435	54.60

PUSHBUTTONS

D22 Joy stick operator - Spring return to center



Up
|
Down

Two Position

D22 MS414 \$83.60



Complete with two CII (SEII) Contact Blocks

Up
|
Down
Left — Right

Four Position

D22 MS413 \$86.60

JOY STICK CONTROLLER. CONTACT ACTION, WITH 2 CONTACT BLOCKS TYPE C11(Old SE11) (Old No.)

Position	Upper	Left	Middle	Right	Lower																																																																																
	<table border="1" style="font-size: 8px;"> <tr><td>1</td><td>2</td><td>3</td><td>4</td></tr> <tr><td>5</td><td>6</td><td>7</td><td>8</td></tr> <tr><td>9</td><td>10</td><td>11</td><td>12</td></tr> <tr><td>13</td><td>14</td><td>15</td><td>16</td></tr> </table>	1	2	3	4	5	6	7	8	9	10	11	12	13	14	15	16	<table border="1" style="font-size: 8px;"> <tr><td>17</td><td>18</td><td>19</td><td>20</td></tr> <tr><td>21</td><td>22</td><td>23</td><td>24</td></tr> <tr><td>25</td><td>26</td><td>27</td><td>28</td></tr> <tr><td>29</td><td>30</td><td>31</td><td>32</td></tr> </table>	17	18	19	20	21	22	23	24	25	26	27	28	29	30	31	32	<table border="1" style="font-size: 8px;"> <tr><td>33</td><td>34</td><td>35</td><td>36</td></tr> <tr><td>37</td><td>38</td><td>39</td><td>40</td></tr> <tr><td>41</td><td>42</td><td>43</td><td>44</td></tr> <tr><td>45</td><td>46</td><td>47</td><td>48</td></tr> </table>	33	34	35	36	37	38	39	40	41	42	43	44	45	46	47	48	<table border="1" style="font-size: 8px;"> <tr><td>49</td><td>50</td><td>51</td><td>52</td></tr> <tr><td>53</td><td>54</td><td>55</td><td>56</td></tr> <tr><td>57</td><td>58</td><td>59</td><td>60</td></tr> <tr><td>61</td><td>62</td><td>63</td><td>64</td></tr> </table>	49	50	51	52	53	54	55	56	57	58	59	60	61	62	63	64	<table border="1" style="font-size: 8px;"> <tr><td>65</td><td>66</td><td>67</td><td>68</td></tr> <tr><td>69</td><td>70</td><td>71</td><td>72</td></tr> <tr><td>73</td><td>74</td><td>75</td><td>76</td></tr> <tr><td>77</td><td>78</td><td>79</td><td>80</td></tr> </table>	65	66	67	68	69	70	71	72	73	74	75	76	77	78	79	80
1	2	3	4																																																																																		
5	6	7	8																																																																																		
9	10	11	12																																																																																		
13	14	15	16																																																																																		
17	18	19	20																																																																																		
21	22	23	24																																																																																		
25	26	27	28																																																																																		
29	30	31	32																																																																																		
33	34	35	36																																																																																		
37	38	39	40																																																																																		
41	42	43	44																																																																																		
45	46	47	48																																																																																		
49	50	51	52																																																																																		
53	54	55	56																																																																																		
57	58	59	60																																																																																		
61	62	63	64																																																																																		
65	66	67	68																																																																																		
69	70	71	72																																																																																		
73	74	75	76																																																																																		
77	78	79	80																																																																																		
	<table border="1" style="font-size: 8px;"> <tr><td>1</td><td>2</td><td>3</td><td>4</td></tr> <tr><td>5</td><td>6</td><td>7</td><td>8</td></tr> <tr><td>9</td><td>10</td><td>11</td><td>12</td></tr> <tr><td>13</td><td>14</td><td>15</td><td>16</td></tr> </table>	1	2	3	4	5	6	7	8	9	10	11	12	13	14	15	16		<table border="1" style="font-size: 8px;"> <tr><td>17</td><td>18</td><td>19</td><td>20</td></tr> <tr><td>21</td><td>22</td><td>23</td><td>24</td></tr> <tr><td>25</td><td>26</td><td>27</td><td>28</td></tr> <tr><td>29</td><td>30</td><td>31</td><td>32</td></tr> </table>	17	18	19	20	21	22	23	24	25	26	27	28	29	30	31	32		<table border="1" style="font-size: 8px;"> <tr><td>33</td><td>34</td><td>35</td><td>36</td></tr> <tr><td>37</td><td>38</td><td>39</td><td>40</td></tr> <tr><td>41</td><td>42</td><td>43</td><td>44</td></tr> <tr><td>45</td><td>46</td><td>47</td><td>48</td></tr> </table>	33	34	35	36	37	38	39	40	41	42	43	44	45	46	47	48																																
1	2	3	4																																																																																		
5	6	7	8																																																																																		
9	10	11	12																																																																																		
13	14	15	16																																																																																		
17	18	19	20																																																																																		
21	22	23	24																																																																																		
25	26	27	28																																																																																		
29	30	31	32																																																																																		
33	34	35	36																																																																																		
37	38	39	40																																																																																		
41	42	43	44																																																																																		
45	46	47	48																																																																																		

SERIES D22 INSTALLATION INSTRUCTIONS

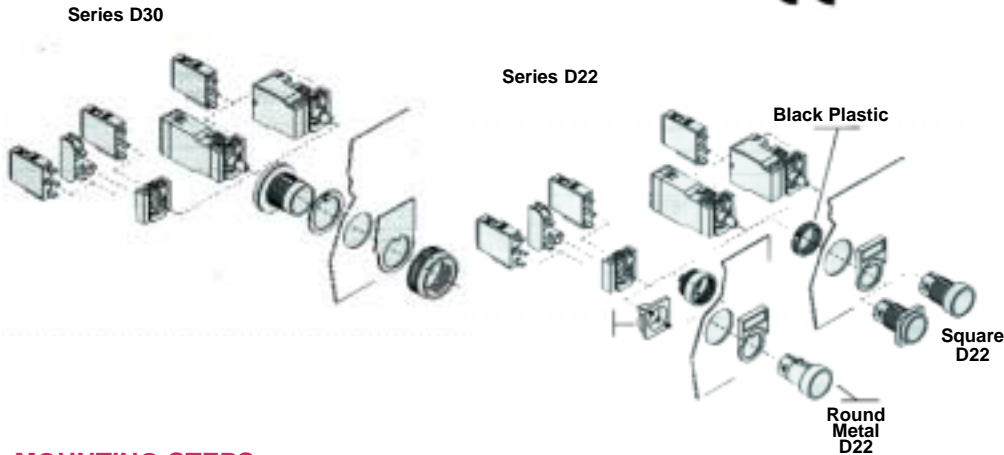

PUSH-PULL OPERATORS (Maintained Operation)



Name Plate
Not Included

Type D22-LPS-C11 Push-Pull \$68.00

Illuminated mushroom less Name Plate.
(Complete with N.O. & N.C. contact blocks.)
Push-pull units are supplied as standard
with light socket (BL9SB). To make
illuminated add bulb BA-9 from page PB 5.



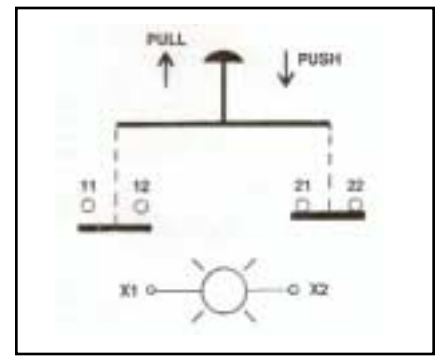







Above Name Plate D22-AU-H \$3.00



MOUNTING STEPS

1. Place Operator into 7/8" Mounting Hole with slot up. Mounting hole can be circle or circle with notch.
2. At rear of panel add optional locking ring. Tab on type A Name Plate supplies anti twist function.
3. Fit Coupler Ring, unscrewed as shown, onto slot in operator
4. Then screw ring to right to fix *tight* the operator panel.
5. Snap Contact Holder into operator.
6. Snap Contact Block onto operator.

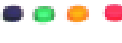
D22 ACCESSORIES

	Cat. No.	Accessory	List.		Cat. No.	Accessory	List.
	D22 S	Optional Two Screw Mount	\$ 1.60 \$ 1.60		D22-PB-KEY-420	Key for D22 and D30 Selector Switch	\$ 2.60
	D-MR	Screw Ring Mount	1.60		D22-PB-KEY-427	Key for D22 and D30 Mushroom Operator	\$ 2.60
	D22 PB-368	Transparent Protective boot for pushbutton/ illum. pushbutton operators.	5.20		D22-PL-GUARD	Pad Lockable guard with clear cover	\$15.00
	D22 PB-377	Hole Plugs	2.60		C22-A	Tightening Wrench for Plastic Ring Mounting	\$20.00
	D22 PB-376	Hole Reducers 30 to 22 mm 1 13/64" to 7/8"	1.00		C22	Tightening Wrench Round Metal Ring used on D-MC-4	\$20.00
					Red-D22-PB-40 Green-D22-PB-50 Yellow-D22-PB-55 Blue-D22-PB-58	Pushbutton Illuminated Replacement Lens	\$.50
	D22 R-10	Through Door Reset Operator	13.00		Red-D22-PL-40 Green-D22-PL-50 Yellow-D22-PL-55 Blue-D22-PL-58	Pilot light Replacement Lens	\$.50

PUSHBUTTONS

Pushbuttons (Includes Operator, Holder, Contact Block & Incadescent Bulb,
and Pilot Light Socket)

600 Volt

**ASSEMBLED
PUSHBUTTONS and PILOT LIGHTS**



LED Bulbs Available
Page PB 13



Assembled Pushbuttons

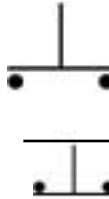

Color	Flush	List	Extended	List
Black	D30 PR 10-1	\$22.10	D30 PS 10-1	\$22.10
Green	D30 PR 10-3	22.10	D30 PS 10-3	22.10
Gr Start	D30 PR 10-Start	23.00	D30 PS 10-Start	23.00
Yellow	D30 PR 10-4	22.10	D30 PS 10-4	22.10
Blue	D30 PR 10-5	22.10	D30 PS 10-5	22.10
Red	D30 PR 01-2	22.10	D30 PS 01-2	22.10
Red - Stop	D30 PR 01-Stop	23.00	D30 PS 01-Stop	23.00

Illuminated Pushbuttons (Includes Lens, Socket, Bulb, and Contact Block)

Full Voltage

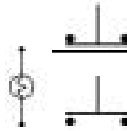

Color	Flush	List	Extended	List
Red	D30 PRL01-2-†	38.00	D30 PRLGM01-2-†	43.10
Green	D30 PRL10-3-†	38.00	D30 PRLGM10-3-†	43.10
Yellow	D30 PRL10-4-†	38.00	D30 PRLGM10-4-†	43.10
Blue	D30 PRL10-5-†	38.00	D30 PRLGM10-5-†	43.10
White	D30 PRL10-6-†	38.00	D30 PRLGM10-6-†	43.10

Pilot Lights (Includes Lens, Bulb, and Socket)



Color	Full Voltage Type	List	Transformer Type	List
Red	D30 S9S-2-†	30.00	D30 SBT-2-†	58.50
Green	D30 S9S-3-†	30.00	D30 SBT-3-†	58.50
Yellow	D30 S9S-4-†	30.00	D30 SBT-4-†	58.50
Blue	D30 S9S-5-†	30.00	D30 SBT-5-†	58.50
White	D30 S9S-6-†	30.00	D30 SBT-6-†	58.50

Push-to-Test (Full Voltage)



Color	Part Number	List	Color	Part Number	List
Red	D30 PRL11-2-†	46.00	Blue	D30 PRL11-5-†	46.00
Green	D30 PRL11-3-†	46.00	White	D30 PRL11-6-†	46.00
Yellow	D30 PRL11-4-†	46.00	Note: Trans. Type not Available		

Mushroom Pushbuttons Red



Type	35mm Mushroom	List	60mm Mushroom	List
Momentary	D30 PF-01	35.10	D30 PF60-01	40.60
Twist Type	D30 PFB-01	53.20	D30 PBB60-01	58.60
Key to Release	D30 PFBC-01	58.60		
Pull to Release	D30 PFBPT-01	53.20	D30 PFBTP 60-01	58.60

Selector Switch (Maintained)



2 Pos
3 Pos

Type	Black Handle	List	Keyed	List
OX	D30 SN - A10	27.30	D30 SC - E10 ◀◀	56.60
XOO	D30 SN - E20*	35.30	D30 SC - E20- ◀◀*	64.00
OOX				

* Includes two C10B N.O. Contacts

◀◀ Select Key Removal Suffix From PB12

† Voltage Selection	ADD NAME PLATES See Page PB 14	Type D30-U-X Blank	1.60	Type D30-UL-X Blank	2.60
- G 24 v Full Voltage					
- A 110v					
- C 230v Trans.					
- D 380v Trans.					

LED Lamps Available - See Page PB 13

For High Output LED, use suffix HL and add \$15.00 to list price

PUSH BUTTON OPERATOR MODULES

HEAVY DUTY OIL TIGHT PUSH BUTTONS / PILOT LIGHTS

600V
CE

Each Operator Module is supplied complete with Block Holder

FLUSH 	EXTENDED 	ILLUMINATED (Flush) 	ILLUMINATED WITH GUARD 	ILLUMINATED
D30 PR-* \$14.10	D30 PS-2 \$14.10 (Red) -2, (Green) -3, (Black) -4	D30 PRL-* \$14.10	D30 PRLGM-* \$19.20 GUARD ONLY D30-G \$4.00	D30 PSL-* \$14.10

MUSHROOM (MOMENTARY) 35MM OR 60MM (Red) 	Twist to Release 40mm or 60mm (Red) 	Pull to Release (Red) 	Key to Release (Red) 		
D30 PF-2 \$27.10	D30 PF 60-2 \$32.60	D30 PFB-2 \$45.20	D30 PFBPT-2 \$50.60	D30 PFB PTL2 \$45.20	D30 PFBC-2 \$50.60
D30 PFL-2 \$27.10 ILLUMINATED			D30 PFB PTL 60-2 (60mm HEAD) ILLUMINATED \$48.20		

SELECTOR SWITCH 	ILLUMINATED SECTOR SWITCH 	KEY SELECTOR SWITCH
D30/SN-1-◇ \$19.50	D30/SL-* -◇ \$19.50	D30/SC-1-◇ -◇ \$48.60

2 Position		Block C01B	Cam-◇
Left-Right	Maintained	O X	-A
Center-Right	Maintained	O X	-CD
Center-Right	Spring to Center	O X	-CD/RD

3 Position		Cam-◇
Left-Center-Right	Maintained	-E
Left-Center-Right	Spring to Center	-ERC
Left-Center-Right	Spring Right to Center	-ERD
Left-Center-Right	Spring Left to Center	-ERS

TABLE FOR SELECTION OF THE KEY WITHDRAW POSITION IN SELECTOR SWITCHES

See page PB 13 for Contact Block
See page PB 14 for Name Plates

* Letter to be added to the selector switch catalogue number according to chosen key withdraw position.

NOTE: In selector switches with spring return to center, key can be withdrawn only in center position.

Example: D30SC-1-E-U Key Operated

Order Examples Selector Switch

- D30 SN-1-A (2 Position) Operator
- D30 SN-1E (3 Position) Operator
- Assembled 3 Position D30 SN-1-E & 2C10B (Old No. 2SE10)

Nameplate: #D30-U-A "Start" = \$1.60

Order Examples Push Button

Green Operator only List #D30PR-3 \$14.10

Complete Push Button

Green Operator plus NO contract Block #D30PR-3-C10B \$14.10 + \$8.00 = \$22.10

- * COLOR CODE

- 1 BLACK
- 2 RED
- 3 GREEN
- 4 YELLOW
- 5 BLUE
- 6 WHITE

CODE	LEFT	CENTER	RIGHT
U	yes	no	no
V	no	yes	no
W	no	no	yes
X	yes	yes	no
Y	yes	no	yes
Z	no	yes	yes
J	yes	yes	yes



Metal Legend Plate:
Round Yellow E-STOP 2 3/4" Diam. D30-NPES-275 \$4.25 ea.
(Used with 30mm operators)

LED Lamps Available - See Page PB 13

FULL SIZE PUSHBUTTONS



COMPLETE UNIT



OPERATOR WITH BLOCK HOLDER

+



CONTACT BLOCK

Block Holder

Price of Block Holder is included as part of Operator Module.



CATALOG NUMBER	LIST
(Spare) D22 BN	\$2.60

Type BN Block Holder accepts 2 Blocks. (4 poles)
For 6 poles, add insert plug:
Catalog No. D22-P \$4.00 List

PUSH-PULL OPERATORS (Maintained Operation)



Type D30/PFBTL-2-C11
Push-Pull Illuminated Mushroom.
(Complete with N.O. & N.C. contact blocks, with 120v bulb & socket)
Less Name Plate List \$73.20
Name Plate D30-AU-H \$ 3.00

Contact Block (Standard 10 Amp) Same Contact Blocks are used on D22 Size.



	New No.	Old No.	List
1NO	C10B*	SE10	\$ 8.00
2NO	C20	SE20	16.00
1NC	C01B*	SE01	8.00
2NC	C02	SE02	16.00
1NO, 1NC	C11	SE11	16.00

PILOT LIGHTS AND LIGHT SOCKETS

Pilot Light Socket - Same Light Sockets are used on Sizes D22 and D30.
(used on Pilot Lights, Illuminated P.B., and Push-To-Test)

Pilot Light



D30 S-* \$14.10

Light Socket	Reduced From Full Voltage	LIST	BA-9	BULB
Full Voltage	BL9SB	110V \$12.00	Add Bulb	(2 watt max)
Series Resistor 208/230	BR 220†	110V 27.30	BA9-6V	2.60
Series Resistor 120V	BR 110	48V 23.40	BA9-24V	2.60
Transformer Type	BT 110*	24V 44.40	BA9-48V	2.60
	BT 220*	24V 44.40	BA9-110V	3.90
	BT 380*	24V 44.40		

* Transformer Type Includes 1, 2 Watt Max Incandescent Bulb (BA9-24V) † = Includes Bulb BA9-130V

- * COLOR CODE

- 1 BLACK
- 2 RED
- 3 GREEN
- 4 YELLOW
- 5 BLUE
- 6 WHITE

STANDARD LED BULBS		Hi-Lumen Output LED Bulbs (BA9-Base)		
LED LIST	Part No.	Description	LED List	
24v DC BA9L24DC*	HLR24	Red 24v AC/DC	\$18.00	
24v AC BA9L120AC*	HLY24	Yellow 24v AC/DC	18.00	
120v AC BL9120AC*	HLG24	Green 24v AC/DC	18.00	
*Add color R-Red G-Green Y-Yellow	HLR110	Red 110v AC	18.00	
	HLY110	Yellow 110v AC	18.00	
	HLG110	Green 110v AC	18.00	

For complete units see page PB 11

Price of LED Lamp not included in price of Operator.

THREE POSITION SELECTOR SWITCH Contact Sequence CAM Type "E"

LEFT CONTACT CENTER CONTACT RIGHT CONTACT BLOCK

1	0 0 0 0 0 0	0 0 0 0 0 0	0 0 0 0 0 0	C10 + 10 (SR10 + 10)
2	0 0 0 0 0 0	0 0 0 0 0 0	0 0 0 0 0 0	C10 + 01 (SR10 + 01)
3	0 0 0 0 0 0	0 0 0 0 0 0	0 0 0 0 0 0	C01 + 01 (SR01 + 01)
4	0 0 0 0 0 0	0 0 0 0 0 0	0 0 0 0 0 0	C01 + 10 (SR01 + 10)
5	0 0 0 0 0 0	0 0 0 0 0 0	0 0 0 0 0 0	C11 + 11 (SR11 + 11)

(Old No.)

See Page PB 7 for Additional Contact Sequence

D30 JOY STICK OPERATOR



1

D30/M-1 \$84.00

Position	Up	Left	Center	Right	Down	SP Contact
4 MO	0 0 0 0 0 0	0 0 0 0 0 0	0 0 0 0 0 0	0 0 0 0 0 0	0 0 0 0 0 0	11 + 11
2 MO	0 0 0 0 0 0	0 0 0 0 0 0	0 0 0 0 0 0	0 0 0 0 0 0	0 0 0 0 0 0	11 + 11

Example: D30 M-1-4 MO (Momentary)

*Operator supplied with 2 NO plus 2 NC Contacts.



LEGEND PLATES

EXTRA LARGE



Type D30-U*
H W
1.77" 1.57"
List
\$1.60



Type D30-UL*
H W
2.05" 1.81"
List
\$2.60



Type AB
2 7/16" Square
List
\$2.60



Type AU
2 7/16" Square
List
\$2.60

Start	D30-U-A	D30-UL-A	D30-AB-A	D30-AU-A
Stop (Type U-Red)	D30-U-B	D30-UL-B	D30-AB-B	D30-AU-B
Forward	D30-U-C	D30-UL-C	D30-AB-C	D30-AU-C
Reverse	D30-U-D	D30-UL-D	D30-AB-D	D30-AU-D
On	D30-U-E	D30-UL-E	D30-AB-E	D30-AU-E
Off	D30-U-F	D30-UL-F	D30-AB-F	D30-AU-F
Inch	D30-U-G	D30-UL-G	D30-AB-G	D30-AU-G
Fwd Off Rev	D30-U-I	D30-UL-I	D30-AB-I	D30-AU-I
Up off Down	D30-U-J	D30-UL-J	D30-AB-J	D30-AU-J
Hand Off Auto	D30-U-K	D30-UL-K	D30-AB-K	D30-AU-K
Manual Auto	D30-U-L	D30-UL-L	D30-AB-L	D30-AU-L
On Off	D30-U-M	D30-UL-M	D30-AB-M	D30-AU-M
Off On	D30-U-N	D30-UL-N	D30-AB-N	D30-AU-N
Emergency Stop	D30-U-O	D30-UL-O	D30-AB-O	D30-AU-O
High Off Low	D30-U-P	D30-UL-P	D30-AB-P	D30-AU-P
Blank	D30-U-X	D30-UL-X	D30-AB-X	D30-AU-X

Special Marking Name Plates \$6.80

Legend Plate Maximum Letters Including Spaces Across - 2 line max:

D30-UL	17	D22-R (Round)	12	D22-AU	18
D30-AU	18	D22-S (Square)	12		

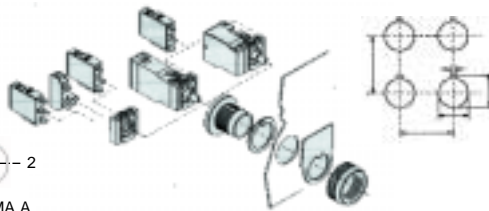

FORMA B FORMA A

	Inches
MOUNTING DIMENSIONS	
A	1.2" (1 13/64")
B	1.9" (1.5" min.)
C	2.5" (1.5" min.)
D	1.3"
E	0.2"

30mm ACCESSORIES



Tightening Wrench
C30 \$20.00



Hole Plug
D30T30 \$2.60



Boot
-* Color Code
From Page PB12
D30P30 \$5.20



3 1/8" DSC1-90



2" D22-SC1-50D



D22-SC1-130

(*See Page PB 16 for additional E-Stops)



All N.C. Pushbutton contacts are positive break designed for Safety Requirements. All units below include 1 N.C. contacts.

COMPACT DESIGN—

Non Metal - NEMA 1 - Units include 1 N.C. PALM MUSHROOM LATCH BUTTON*

D-SC1-90 (2" deep) NEMA 1	List \$29.00
D-SC1-90D (2 3/4" deep) NEMA 1	List 30.00

Non Metal IP65, NEMA 4 - Units include 1 N.C. Outdoor Hose Test, Water Tight. STANDARD MUSHROOM*

D22-SC1-40D momentary	\$34.00
D22-SC1-50D maintained	47.00
D22-SC1-120 non indicator type	57.00
D22-SC1-130 indicator type	59.00
Enclosures only, D22-SD1-D	14.00

Additional N.O. or N.C. Contacts can be added to these control stations. To add 1 N.O. contact use suffix - 11 at end of part # Add \$8.00 List. To add 1 N.C. contact use suffix - 02 at end of part # Add \$8.00 List



RESET OPERATOR
D30R10 \$13.00

Disc. Sched. PB

See Page PB 4 For Standard 7/8" Reset

ENCLOSURES ONLY - FULL SIZE (1 13/64" Drilling for Field PB Mounting)

# Holes	Scarlex S4 (PVC) Light Duty Cat. No. -D30	List	Dimensions (Inches)		
			Height	Width	Depth*
1	S4-256-S1	\$ 12.00	4.0	4.0	2.1
1	S4-318-S1	15.00	5.3	2.8	2.2
2	S4-318-S2	16.50	5.3	2.8	2.2
3	S4-336-S3	27.00	6.7	4.2	2.7
4	S4-356-S4	30.00	6.7	5.4	2.7
6	S4-356-S6	36.00	6.7	5.4	2.7
8	S4-362-S8	45.00	8.6	6.6	3.6
12	S4-372-S12	110.00	11.1	8.7	4.3

ENCLOSURES ONLY - FULL SIZE (1 13/64" Drilling for Field PB Mounting) NEMA 12/13

# Holes	M4-D30	M4-D22	List	Height	Width	Depth*
1	M4-SV1	M4-SMV1	\$36.00	3.2	3.2	3.0
2	M4-SV2	M4-SMV2	42.00	5.6	3.2	3.0
3	M4-SV3	M4-SMV3	47.00	7.7	3.2	3.0
4	M4-SO4	M4-SMO4	57.00	5.7	5.7	3.1
4	M4-SV4	M4-SMV4	57.00	9.7	3.2	3.0
6	M4-SO6	M4-SMO6	68.00	7.7	6.3	3.1

For larger sizes, check with factory.





SERIES D22 & D30 CONTROL STATIONS



**LOW COST
WATER TIGHT
DUST TIGHT
CONTROL STATIONS
WITH D22 & D30 OPERATORS**

**Non Metal PVC
Start-Stop #S4-201 \$ 34.00**

DESCRIPTION

Type S4 Enclosures are Non Metal PVC fully gasketed against dust and hose pressure water tight. (International Rating: IP 66)

Type 4X Enclosures are UL and CSA - Fiberglass Reinforced and are fully gasketed & hose pressure water tight.

Type M4/12 are cast metal and meet NEMA 12/4 standards.

ELECTRICAL RATINGS

All buttons supplied are heavy duty oil dust tight-meet Type 4(water tight) and Type 12/13. Each is 600 Volt, 10 Amp UL, CSA.

Button Size: Part number example: S4-101	D22		D30		D22		D22 Cast Aluminum		D30 Cast Aluminum	
	S4-	LIST	S4-	LIST	S4X-	LIST	M4/12	LIST	M4/12	LIST
ONE BUTTON										
Start	-101	29.00	-121	34.00	-101	54.00	-101	54.00	-121	61.00
Stop	-102	29.00	-122	34.00	-102	54.00	-102	54.00	-122	61.00
Stop (Lockout)	-103	47.00	-123	54.00	-103	65.00	-103	65.00	-123	78.00
Stop (Maintained Mushroom Button)	-104	46.90	-124	52.00	-104	60.00	-104	60.00	-124	70.00
Stop (Momentary Mushroom Button)	-104MO	34.00		42.00						
Jog	-105	31.00	-125	38.00	-105	55.00	-105	55.00	-125	64.00
Off-On (Selector Switch)	-106	31.00	-126	38.00	-106	55.00	-106	55.00	-126	64.00
Open-Close (Selector Switch)	-107	31.00	-127	38.00	-107	55.00	-107	55.00	-127	64.00
For-Rev. (Selector Switch)	-108	31.00	-128	38.00	-108	65.00	-108	65.00	-128	78.00
Hand-Off-Auto (Selector Switch)	-109	31.00	-129	38.00	-109	65.00	-109	65.00	-129	78.00
Man.-Auto (Selector Switch)	-110	31.00	-130	38.00	-110	65.00	-110	65.00	-130	78.00
Red Pilot Light: Resistor Type										
120V 60Hz	-111	55.00	-131	64.00	-111	60.00	-111	60.00	-131	70.00
240V 60Hz	-112	55.00	-132	64.00	-112	60.00	-112	60.00	-132	70.00
Red Pilot Light: Full Voltage Type										
120V AC or DC	-113	43.00	-133	50.00	-113	48.00	-113	48.00	-133	55.00
TWO BUTTON										
Start-Stop	-201	34.00	-221	42.00	-201	84.00	-201	84.00	-221	96.00
On-Off	-202	42.00	-222	49.00	-202	84.00	-202	84.00	-222	96.00
For-Rev.	-203	42.00	-223	49.00	-203	84.00	-203	84.00	-223	96.00
Up-Down	-204	42.00	-224	49.00	-204	84.00	-204	84.00	-224	96.00
Open-Close	-205	42.00	-225	49.00	-205	84.00	-205	84.00	-225	96.00
High-Low	-206	42.00	-226	49.00	-206	84.00	-206	84.00	-226	96.00
Start-Stop (Lockout in Stop)	-207	52.00	-227	59.00	-207	94.00	-207	94.00	-227	112.00
Red Pilot Light, 1 Button:										
120V	-208	65.00	-228	78.00	-208	94.00	-208	94.00	-228	112.00
240V	-209	65.00	-229	78.00	-209	94.00	-209	94.00	-229	112.00
THREE BUTTON										
Start-Jog-Stop	-301	63.00	-321	75.00	-301	106.00	-301	106.00	-321	123.00
Open-Close-Stop	-302	63.00	-322	75.00	-302	106.00	-302	106.00	-322	123.00
Up-Down-Stop	-303	63.00	-323	75.00	-303	106.00	-303	106.00	-323	123.00
For-Rev.-Stop	-304	63.00	-324	75.00	-304	106.00	-304	106.00	-324	123.00
High-Low-Stop	-305	63.00	-325	75.00	-305	106.00	-305	106.00	-325	123.00
Up-Down-Stop	-306	63.00	-326	75.00	-306	106.00	-306	106.00	-326	123.00
Red Pilot Light, 2 Push Buttons										
(Start-Stop)	-307	86.00	-327	100.00	-307	112.00	-307	112.00	-327	132.00
120V AC or DC	-308	86.00	-328	100.00	-308	112.00	-308	112.00	-328	132.00
240V AC or DC										

PUSHBUTTONS

ENCLOSURES ONLY (7/8" Drilling for Field PB Mounting)



S4X-201

# Holes xx	Scarlex S4 (PVC) Cat. No. List D22-S4		NEMA 4X Cat. No. List D22-S4X		Dimensions (Inches) Height Width Depth*		
	1	S4-256-M1	\$ 12.00				
1	S4-318-M1	15.00	S4X-M1	42.00	4.0	4.0	2.1
2	S4-318-M2	16.50	S4X-M2	47.00	5.3	2.8	2.2
3	S4-336-M3	27.00	S4X-M3	57.00	6.7	4.2	2.7
4	S4-356-M4	30.00	S4X-M4	57.00	6.7	5.4	2.7
5	S4-356-M6	36.00	S4X-M6	68.00	6.7	5.4	2.7
6	S4-362-M8	45.00	S4X-M8	90.00	8.6	6.6	3.6
7	S4-372-M12	110.00	S4X-M12	94.00	11.1	8.7	4.3



**S4-318-M2
Enclosure**

For CAST METAL - Same price as S4X Enclosure
Example: D22-M4/12-M1 \$42.00 List

SERIES D22 EMERGENCY STOP PUSHBUTTONS

➔ POSITIVE BREAK N.C. Contact

ONE FIXED N.C. SAFETY CONTACT - Standard

\$19.50 Special Low
List Price



D22PSR01-ES-FIX
Type 1, 3R, 12 IP65
22mm hole mount

\$29.00 List



D22-SC1-90-FIX
Type 1

\$74.90 List



D22-TR01-GES-FIX
Twist to Release

\$46.00 List



D22-SC1-50-FIX
Type 4

\$56.00 List



D22-SC1-100-FIX
(Twist to Release)
Type 4

OPTIONS
• Extra Contact
• 30mm Hole Mount
• Momentary
• Illuminated
• 60mm Mushroom Head
• Over 30 E-Stop Pushbuttons
• Request Full Line Catalog IC-8

Guards to **avoid** accidental activation

For Maintained Buttons







D22 - Guard	<u>List</u> \$28.00
D30 - Guard	\$28.00

For Momentary Buttons

D22 - Shroud	\$ 2.50
--------------	---------



NEMA 1 TWIN PUSHBUTTON CONTROLS AND SIGNALING UNITS

	Part Number	Description	List Price
	D22-SS253	<i>Twin</i> pushbutton operator with 7/8" hole fixing (Operator only with block holder) Includes Start/Stop legend	\$20.40
	D22-SS253C	<i>Twin</i> complete unit includes D22-SS253 plus contacts C10B (NO), C01B (NC) and block holder Includes Start/Stop legend	\$36.40
	D22-SS253-CL-120V	<i>Twin</i> unit, complete with 120V pilot light. Includes block holder, C10B (NO), C01B (NC) contact blocks, socket holder with lamp marked Start/Stop legend	\$47.10
	D22-SS253-RS	<i>Twin</i> (raised stop button) operator only With Start/Stop legend (Operator only with block holder)	\$24.00
	D22-SS253-CL-RS-120V	<i>Twin</i> (raised stop button) complete unit with 120V pilot light. Includes block holder, C10B (NO), C01B (NC) contact block, socket holder with lamp Marked with Start/Stop legend	\$49.00
	D22-SS253-RS3	<i>Triple</i> (raised red stop button) operator only with "FWD" / "STOP" / "REV" legend (Operator only with block holder)	\$24.00

**Clear rubber boot accessory fitting for above units.
Required for water and dust tight NEMA 4X / IP66 applications**

	D22-SS253-B	Twin flush version	\$13.00
	D22-SS253-B-RS	Raised stop button on twin unit	\$13.00
	D22-SS253-B-RS3	Raised center stop button on triple unit	\$13.00

Note: D22-SS253 include a clear lens, as standard, which can be used as an indicating light by addition of light socket BL9SB + Bulb BA9-* (Specify Voltage) Add contact blocks from page PB-7.

* Special Engravings are available with large quantities.